

Guard Locking Switch Plastic Type: SEZYLOCK KLP

FEATURES:



Spring to lock when actuator is inserted. Energise solenoid to unlock.



STAINLESS STEEL HEAD

Solenoid Locking Interlock Safety Switch featuring Guard Holding up to 2000N (200Kg) (F1Max)

The KLP Series of Guard Locking switches have a slim plastic body design and have been developed with a holding force of 2000N to keep medium guard doors closed until hazards have been removed.

The high specification polyester body has a high resistance to chemical and washdown solutions and the stainless steel head provides a durable robust protection of the cam interlock.

IP67 enclosure protection is maintained by a double seal lid gasket design and metal fixings.

They have a slim profile and are designed to fit on 50mm (2") frame sections or to applications where space is restricted.

The Head will rotate to provide up to 8 actuator entry positions.

An LED is available to indicate Lock Status.

Accessories include a Sliding Handle Gate Bolt and lock off actuators.

FUNCTIONAL SPECIFICATIONS:

Positive Break Contacts to EN60947-5-1

High Functional Safety to ISO13849-1

High specification polyester housing with Stainless Steel Head

Connects to most Safety Relays to give up to PLe Cat.4

Will fit on 50mm (2") frame sections or where space is restricted

Quick Connector version available for ease of installation

2NC Safety Circuits:

Solenoid/Lock and Actuator/Guard wired in series

1NO Auxiliary Circuit:

For indication of Actuator Status

1NO Auxiliary Circuit:

For Lock Status (selectable with LED2)

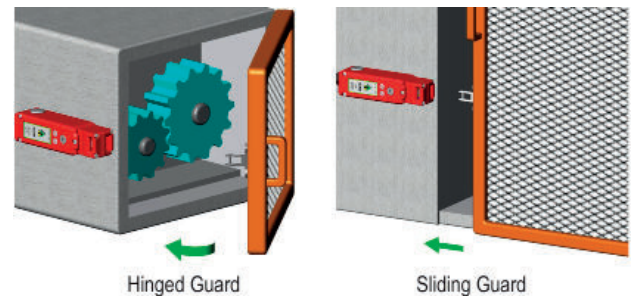

Hinged Guard

Sliding Guard

ACTUATOR OPTIONS (see p100)

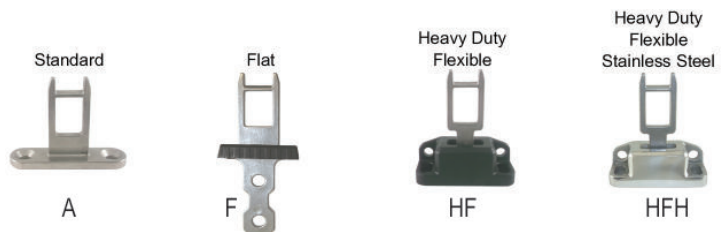

Standards: ISO14119 EN60947-5-1 EN6204-1
ISO13849-1 EN62061 UL508

Safety Classification and Reliability Data:

Mechanical Reliability B10d	2.5 x 10 ⁶ operations at 100mA load
ISO13849-1	Up to PLe depending upon system architecture
EN62061	Up to SIL3 depending upon system architecture
Safety Data – Annual Usage	8 cycles per hour/24 hours per day/365 days
	MTTFd 356 years
Solenoid Voltage (by Sales Number)	24V ac/dc or 110Vac or 230Vac
Solenoid Wattage	12W
LED 2 Supply Voltage	24Vdc
Utilization Category	AC15 A300 3A
Thermal Current (Ith)	5A
Rated Insulation/Withstand Voltages	600Vac/2500Vac
Travel for Positive Opening	10mm
Actuator Entry Minimum Radius	175mm Standard 100mm Heavy Duty
Maximum Approach/Withdrawal Speed	600mm/s
Holding Force	F1Max 2000N Fzh 1538N
Body Material	Polyester
Head Material	Stainless Steel 316
Enclosure Protection	IP67
Operating Temperature	-25C +50C
Vibration	IEC 68-2-6 10-55Hz + 1Hz
	Excursion 0.35mm 1 octave/min
Conduit Entry	Various (See Sales Number)
Fixing	4 x M5



Top or Side Manual Release Points

8 Actuator Entry Positions
Rotable Head

INSERTION OF ACTUATOR

	6.0	5.0	0mm
11/12	Open		
21/22	Open		
33/34			Open
43/44			Open

For all IDEM switches the normally closed (NC) circuits are closed when the guard is closed actuator inserted.

Guard Locking Switch Plastic Type: SEZYLOCK KLP

SCHEMATIC CIRCUIT:

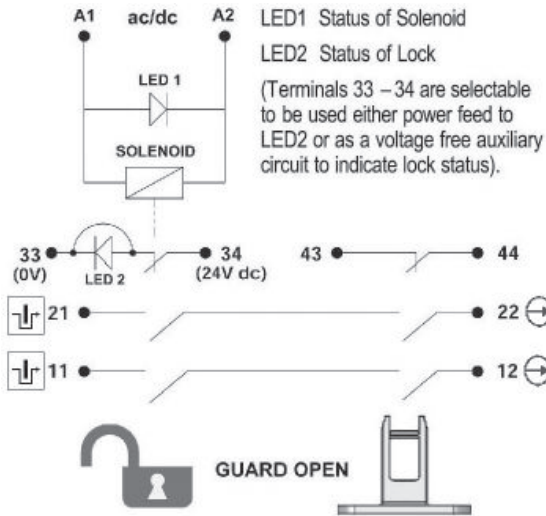

DIMENSIONS:

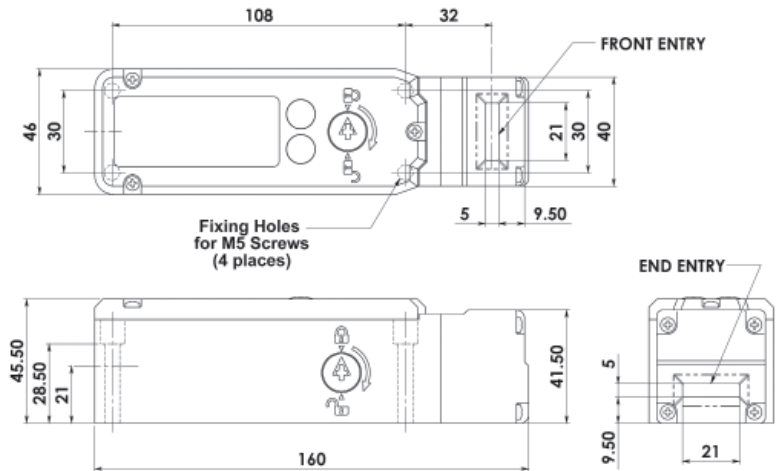

RELATED PRODUCTS & ACCESSORIES (see p100-101 and Gate Bolts Section 6)

GATE BOLT LOCK

Rugged metal construction, easy to install on sliding or hinged guards.

Holes for fitting padlocks during maintenance.

Painted yellow and supplied with plastic handle and flat actuator.

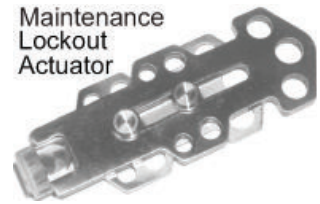

Fits to switch aperture during maintenance and provides multiple padlock holes.



Pin View from Switch	Switch Circuit
1 3	A1 A2
4 6	11/12
7 8	21/22
2 5	43/44
9 10	33/34



FEMALE QC LEADS	LENGTH	SALES NUMBER
M23 12 Way	5m (15ft)	140143
M23 12 Way	10m (30ft)	140144

STANDARD MANUAL RELEASE LID AND SIDE

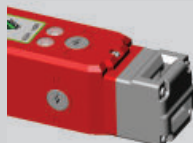

MANUAL RELEASE LID ONLY (Not SIDE)

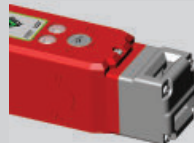

NO MANUAL RELEASE FITTED (Blanked)

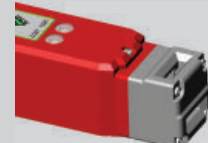

SALES NUMBER	SOLENOID VOLTAGE	M20	1/2" NPT	QC M23	M20	1/2" NPT	QC M23	M20	1/2" NPT	QC M23
Kobra KLP Switch	24V ac/dc	201001	201002	201003	201401	201402	201403	201301	201302	201303
Kobra KLP Switch	110V ac	201004	201005	201006	201404	201405	201406	201304	201305	201306
Kobra KLP Switch	230V ac	201007	201008	201009	201407	201408	201409	201307	201308	201309

Kobra Actuator	Standard	Add A	to Sales Part Number
Kobra Actuator	Flat	Add F	to Sales Part Number
Kobra Actuator	Heavy Duty Flexible	Add HF	to Sales Part Number
Kobra Actuator	S/Steel Heavy Duty Flexible	Add HFH	to Sales Part Number

Ordering Examples:

Kobra KLP 24V Solenoid M20 Conduit Standard Manual Release Heavy Flexible Actuator: Sales Number: 201001-HF
Kobra KLP 110V Solenoid 1/2" NPT Conduit Manual Release Lid only Standard Actuator: Sales Number: 201405-A